

1
2

1
2

- 1 NMCL-32/MEL-002T
- 2 NMCL-05E NMCL-05D
- 3 **G** **U_g** NMCL-31 NMCL-31A SMCL-01
- 4 Uct

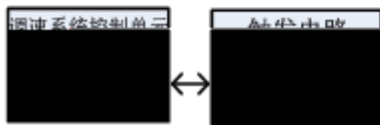
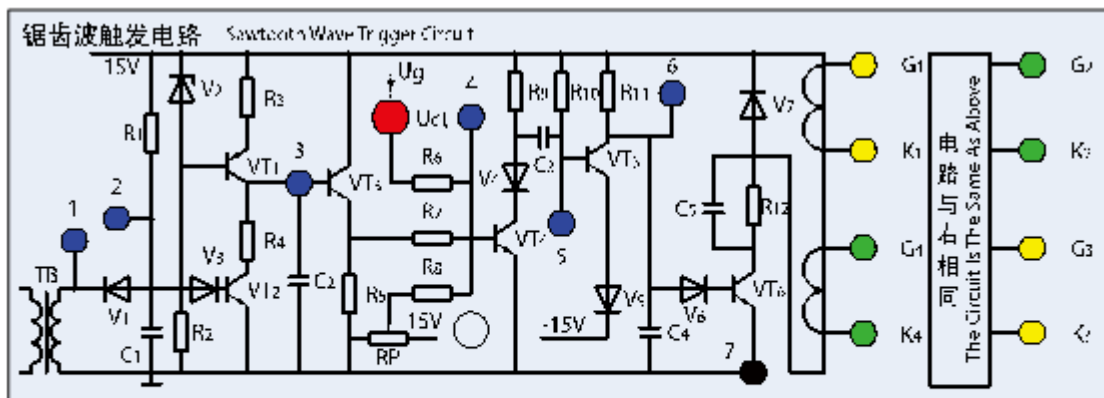

1 2
 3 4
 5 6

1 U V
 2

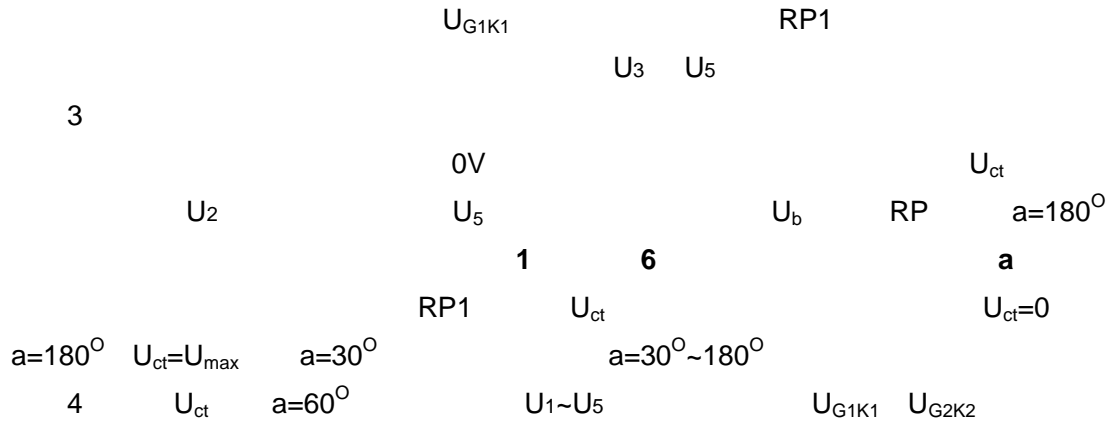

1
 2
 3 U_{ct}=0 a=90°
 4

1
2
3

4 1

1 NMCL-32/MEL-002T
 2 NMCL-05E NMCL-05D
 3 **L** NMCL-331
 4 **Rd** NMEL-03/4 NMCL-03
 5 **G** **Ug** NMCL-31 NMCL-31A SMCL-01
 6 **Uct**
 7 NMCL-33 NMCL-33F

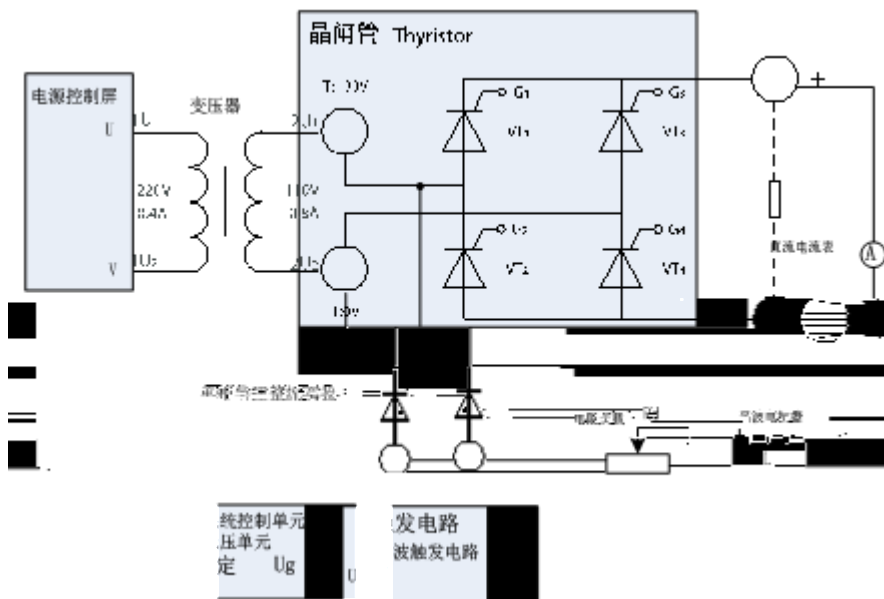

4 1

1
2

1
3
5

2
4
6

1
2
1
2
3
3

5A

$U_{ct}=0$

U_{ct}

U_{ct}

1
a)

U V

b)

U_{G1K1}

U_2

U_5

0V

U_b

RP

U_{ct}

$a=180^\circ$

RP1

U_{ct}

$U_{ct}=0$

$a=180^\circ$

$a=30^\circ \sim 180^\circ$

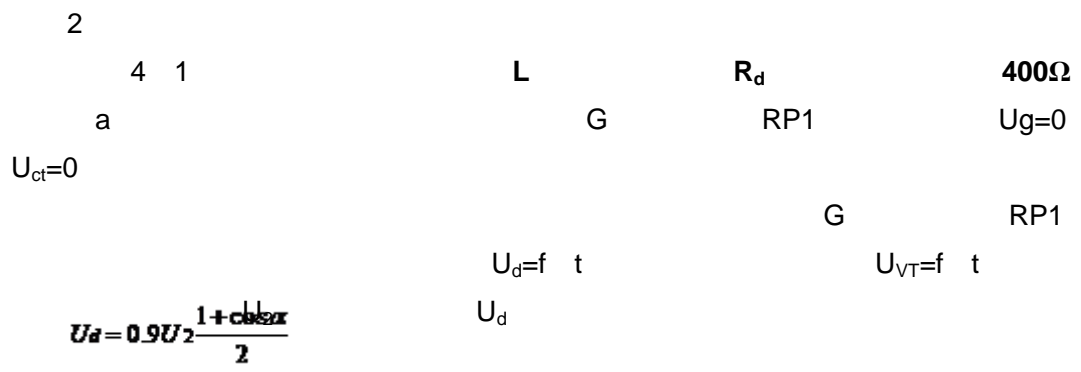

b

U_d U_{vt}

	U_d		U_{vt}	
a=60				
a=90				
a=120				

3

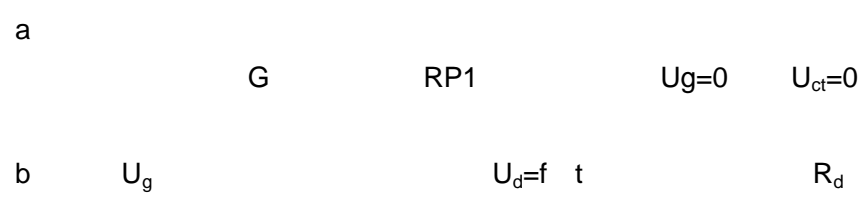

c

U_g 60° 90° 120°

	U_d		U_{vt}	
a=60				
a=90				
a=120				

1
2

1
2

10-1

- | | | | | | |
|---|-----------|-----------|------------------|----------|---------|
| 1 | | | NMCL-32/MEL-002T | | |
| 2 | | | NMCL-05E | NMCL-05D | |
| 3 | Rd | | NMEL-03/4 | NMCL-03 | |
| 4 | G | Ug | NMCL-31 | NMCL-31A | SMCL-01 |
| 5 | Uct | | | | |

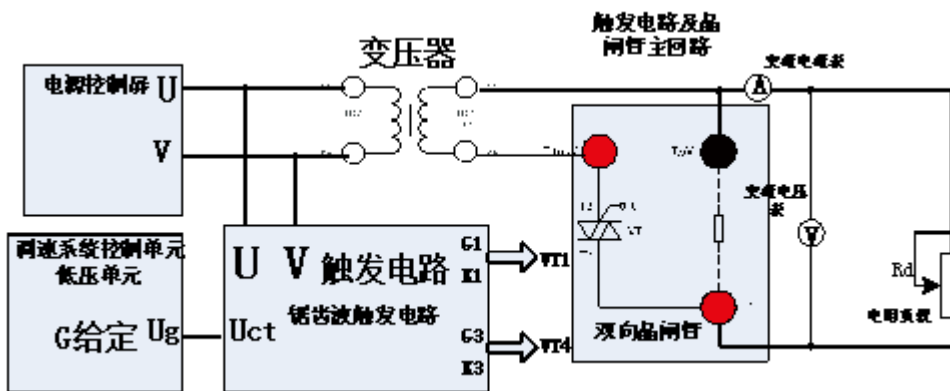

1
3
5

2
4

$a < j$

1

